



★★★★ FOUR STAR LAMPS VERSION C-4 ★★★★★



Add: CN6 Far East Industrial Park, Yuyao, Zhejiang, P.R.China
 Tel: 0086-574-62760092 62760098 62760099
 Fax: 0086-574-62760097
 E-Mail: Jane@fourstarlamps.com Janefsl@163.com
 Alice@fourstarlamps.com Alice.3@163.com
 Http: //www.chinalamp.com
 Http: //www.fourstarlamps.com

 **FOUR STAR LAMPS**
 余姚市四星灯具有限公司
 YUYAO FOUR STAR LAMPS CO.,LTD.

Product feature:

- ※ Die Cast Aluminium Body
- ※ UV Resistant Powder Coating
- ※ PC diffuser
- ※ Brass or Stainless Steel Fasten Patrs

110V~240V / AC 50-60Hz
 Max 60W E26 E27

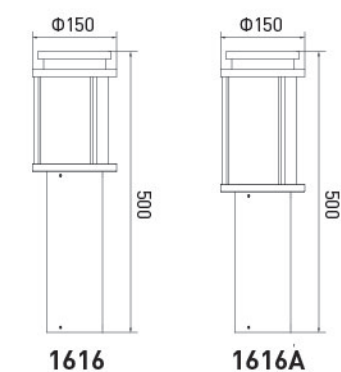
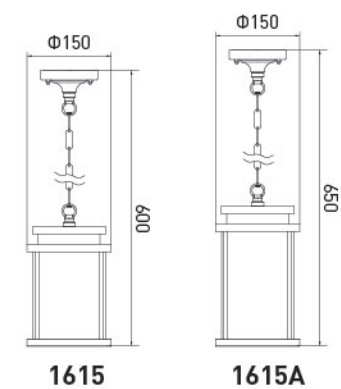
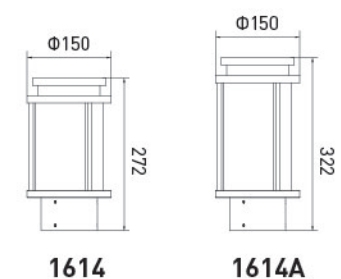
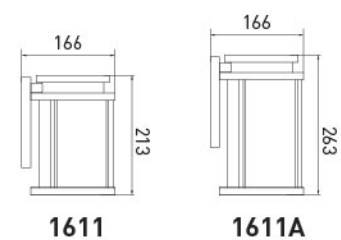
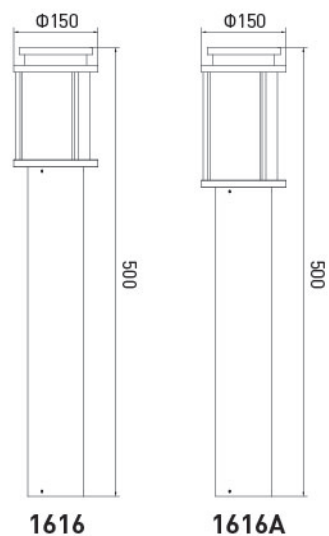

1611



1615



1614

Product feature:

- × Die Cast Aluminium Body
- × UV Resistant Powder Coating
- × Glass diffuser
- × Brass or Stainless Steel Fasten Patrs

110V~240V / AC 50-60Hz
 Max 100W E26 E27

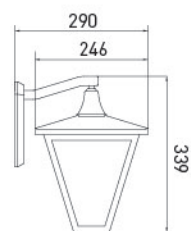

1621

1621

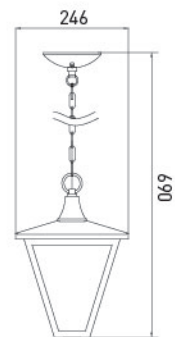

1625



1625

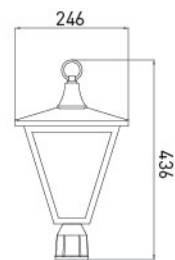

1623



1623

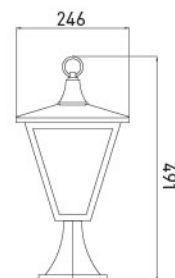

1624



1624

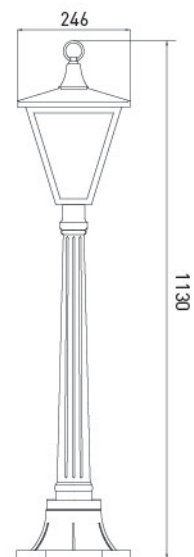

1626



1626

Product feature:

- × Die Cast Aluminium Body
- × UV Resistant Powder Coating
- × Glass diffuser
- × Brass or Stainless Steel Fasten Patrs

110V~240V / AC 50-60Hz
 Max 100W E26 E27



16210

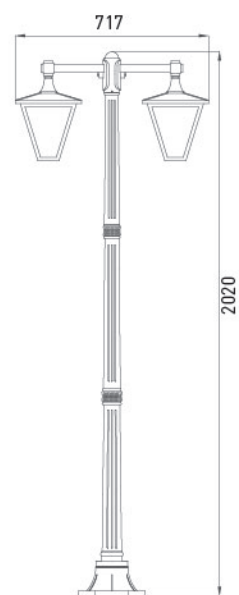

16210



1628



16211

1629

1627

1628

Product feature:

- × Die Cast Aluminium Body
- × UV Resistant Powder Coating
- × Glass diffuser
- × Brass or Stainless Steel Fasten Patrs

110V~240V / AC 50-60Hz
 Max 100W E26 E27

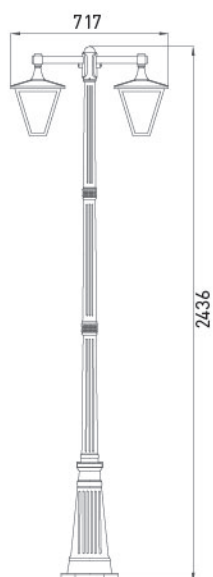

16219

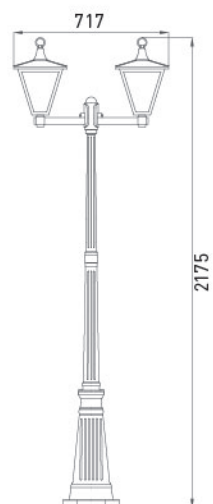

16216



16219



16216

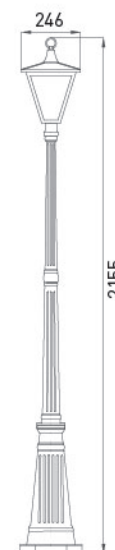

16213



16213



16217



16218



16215

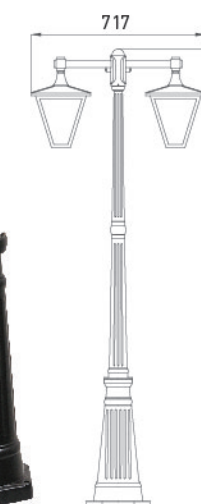

16214

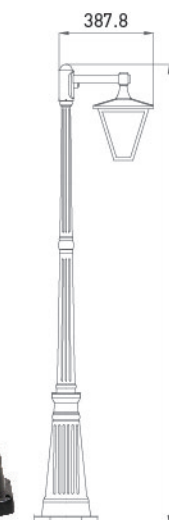

Product feature:

- ※ Die Cast Aluminium Body
- ※ UV Resistant Powder Coating
- ※ Glass diffuser
- ※ Brass or Stainless Steel Fasten Patrs

110V~240V / AC 50-60Hz
 Max 60W E26 E27

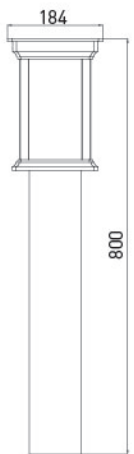

1636

1636

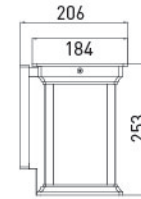

1631



1634

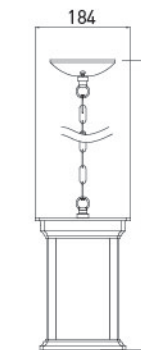

1635

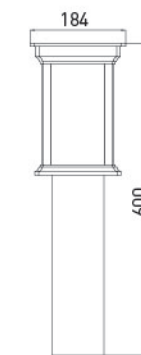

1636



1634



1635



1631

Product feature:

- ※ Die Cast Aluminium Body
- ※ UV Resistant Powder Coating
- ※ Glass diffuser
- ※ Brass or Stainless Steel Fasten Patrs

110V~240V / AC 50-60Hz
 E26 E27



1641 / 1641A

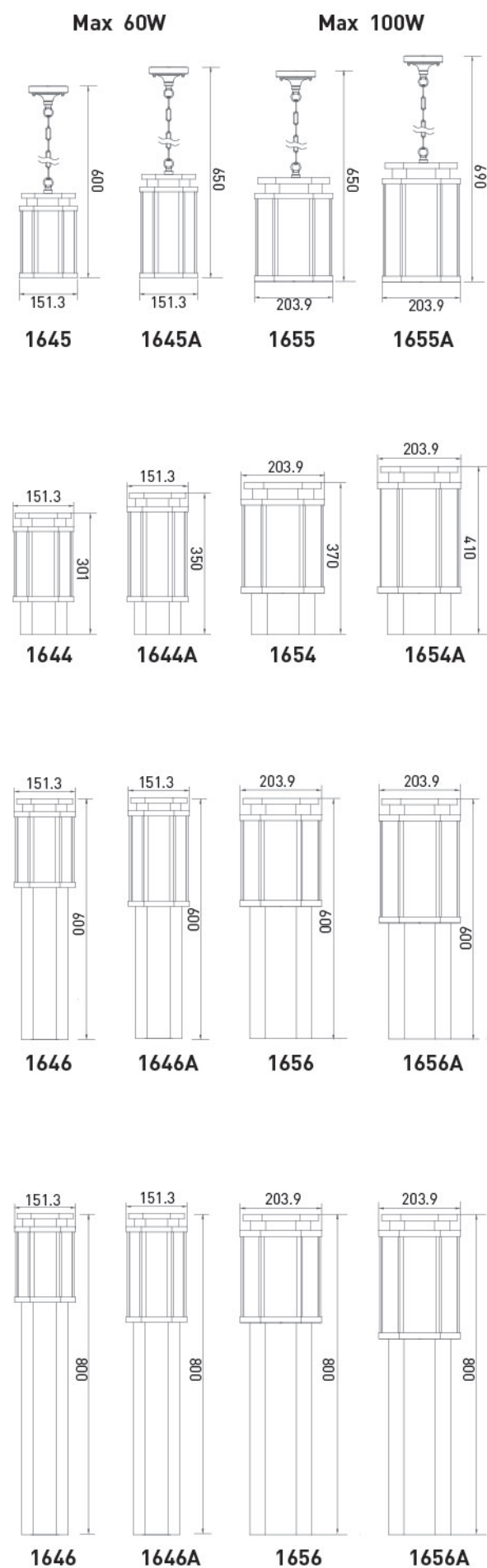
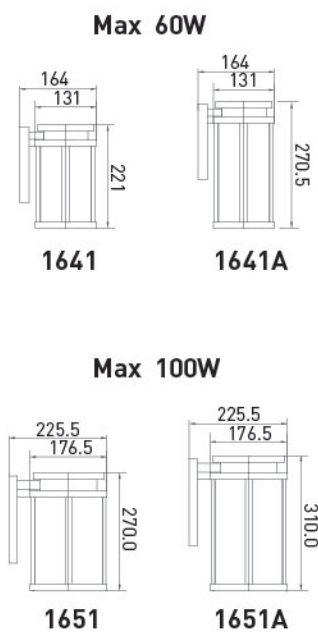

1645 / 1645A



1644 / 1644A

1646 / 1646A

Product feature:

- ※ Die Cast Aluminium Body
- ※ UV Resistant Powder Coating
- ※ Glass diffuser
- ※ Brass or Stainless Steel Fasten Patrs

110V~240V / AC 50-60Hz
 Max 60W E26 E27



1501

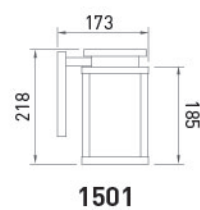

1501

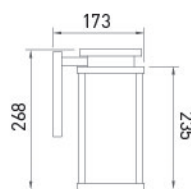

1501A

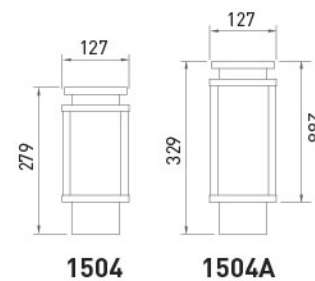

1504 1504A

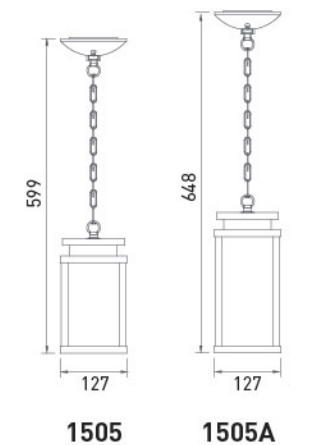

1505 1505A

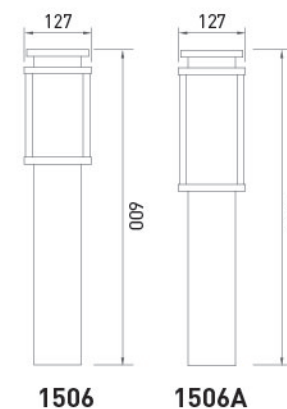

1506 1506A

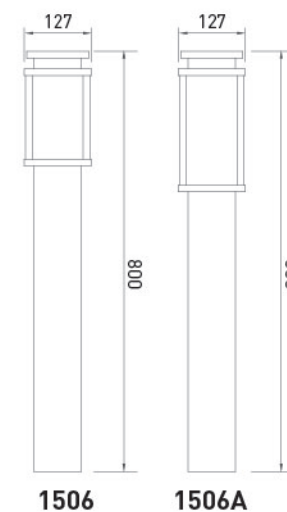

1506 1506A



1504



1505A



1506A

Serie Paladin

Product feature:

- × Die Cast Aluminium Body
- × UV Resistant Powder Coating
- × PC diffuser
- × Brass or Stainless Steel Fasten Patrs

110V~240V / AC 50~60Hz
 E26 E27

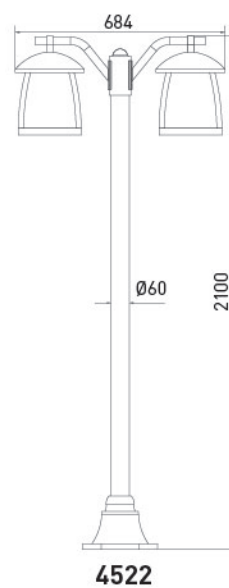
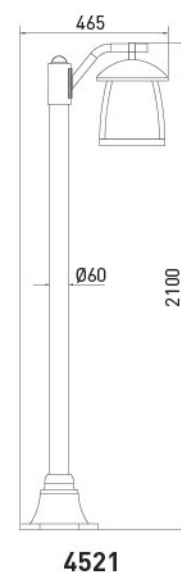
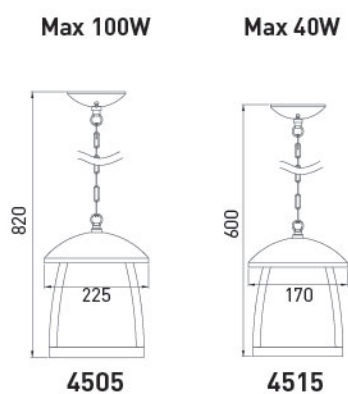
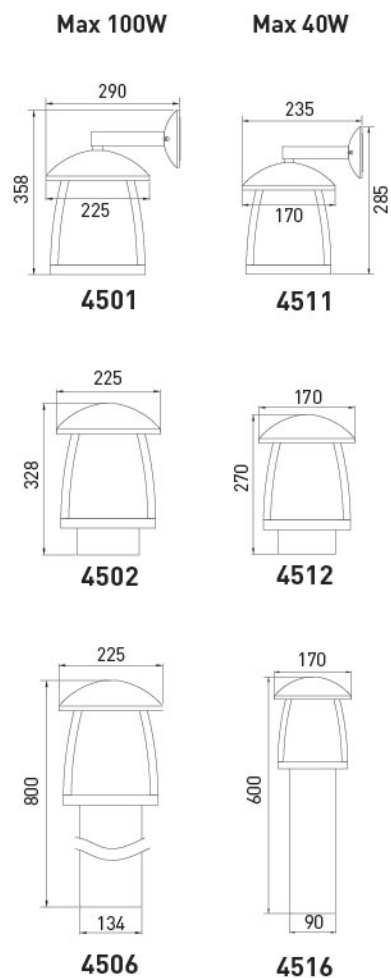

4522



4521



4501



4515



4512

Serie Paladin

Product feature:

- ※ Die Cast Aluminium Body
- ※ UV Resistant Powder Coating
- ※ Glass diffuser
- ※ Brass or Stainless Steel Fasten Patrs

110V~240V / AC 50~60Hz
 E26 E27

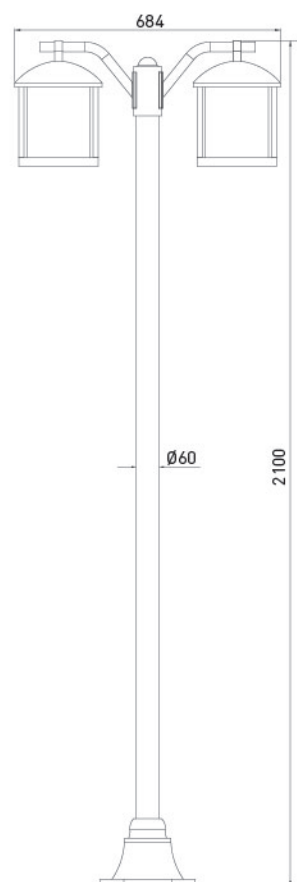

4622



4622

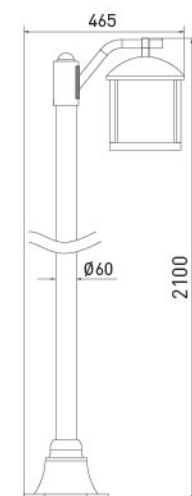
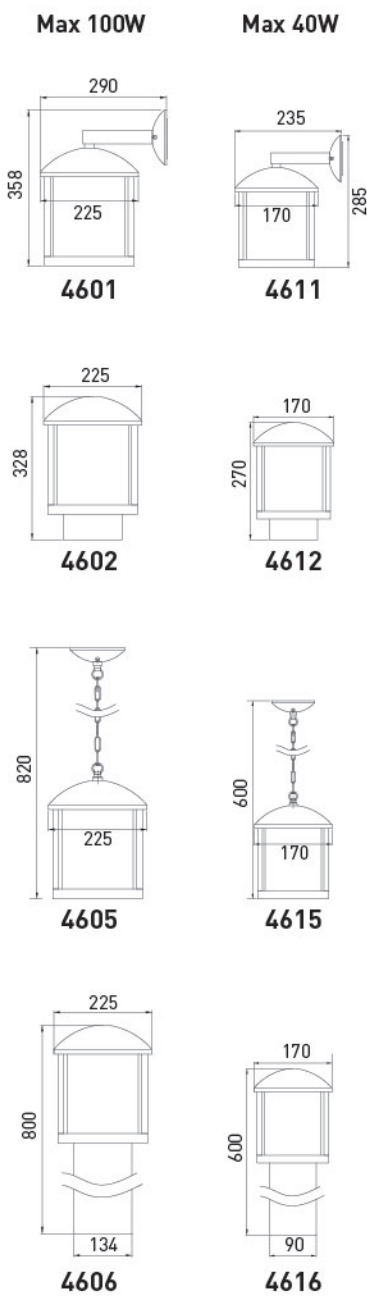

4621



4601



4605



4606



4602



4621

Serie-Rolling

Product feature:

- ✦ Die Cast Aluminium Body
- ✦ UV Resistant Powder Coating
- ✦ PC diffuser
- ✦ Brass or Stainless Steel Fasten Patrs

110V~240V / AC 50~60Hz
 E26 E27

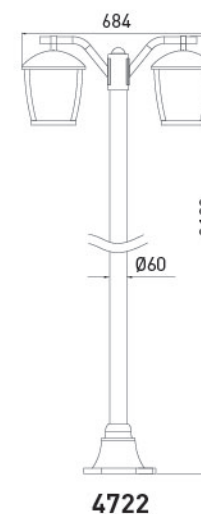
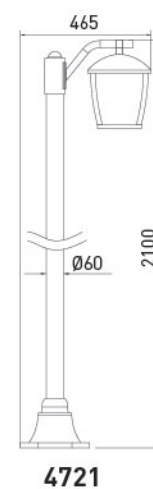
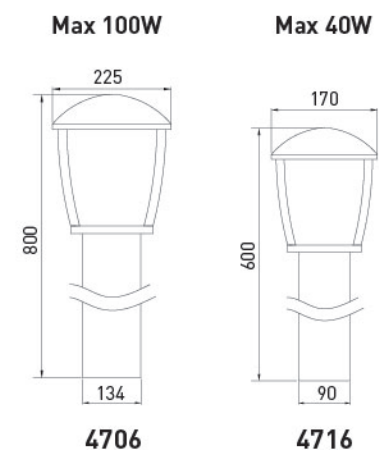
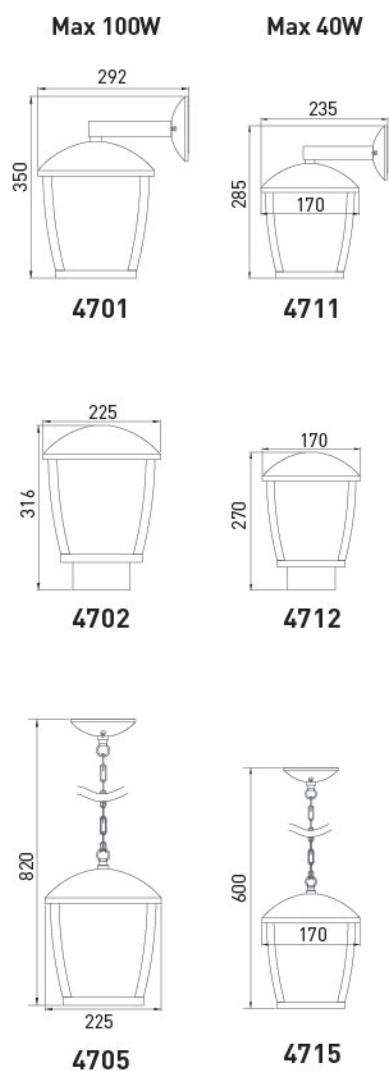

4711



4712



4722



4721



4715



4716

Serie Tim

Product feature:

- ✘ Die Cast Aluminium Body
- ✘ UV Resistant Powder Coating
- ✘ PC diffuser
- ✘ Brass or Stainless Steel Fasten Patrs

110V~240V / AC 50~60Hz
 Max 100W E26 E27

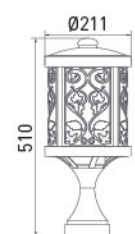

7104

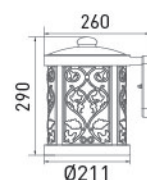

7102

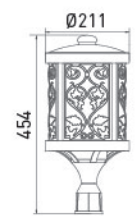

7103

7104

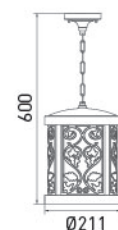

7105

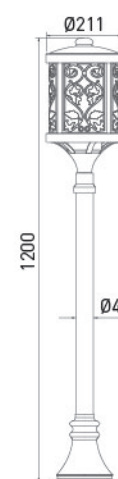

7121

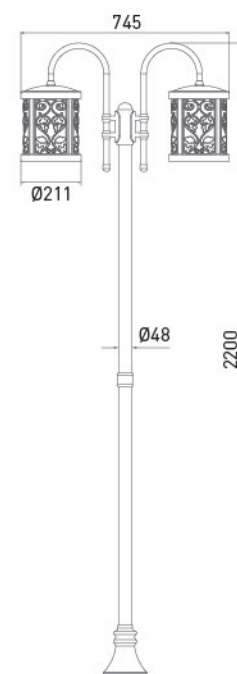

7122

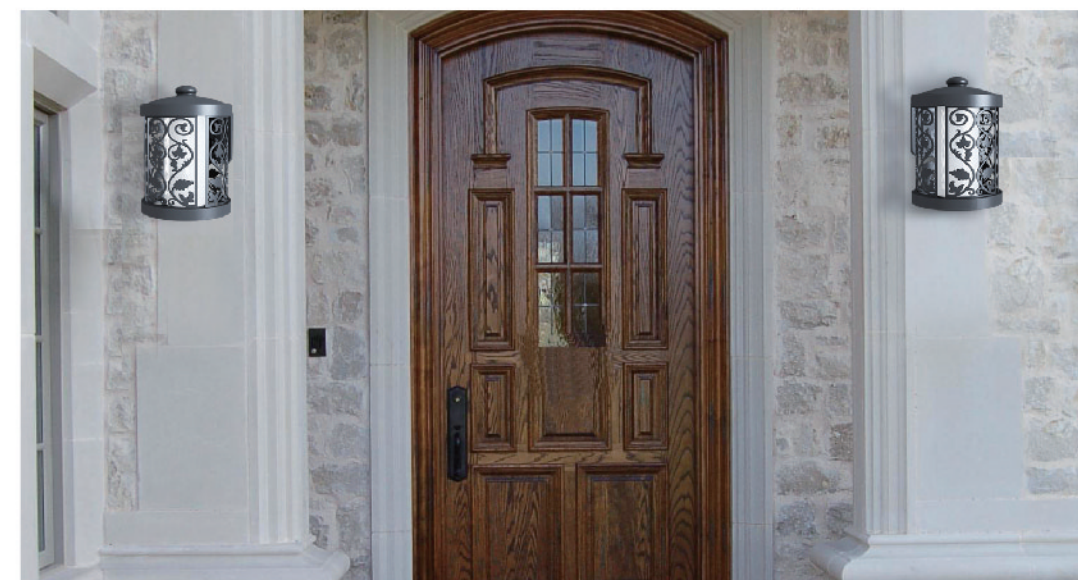

7102



7122



7105



7121

Serie Tim



7131



7110

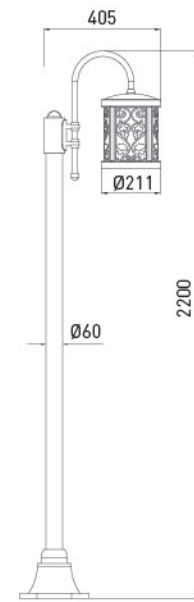

7131

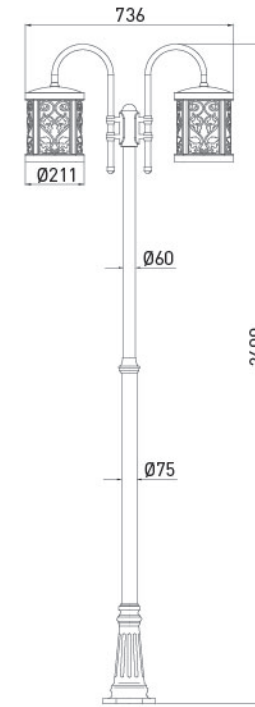

7110



7132

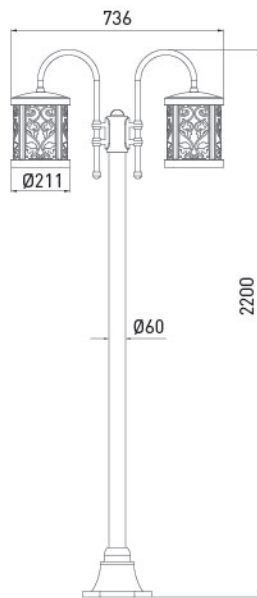

7132

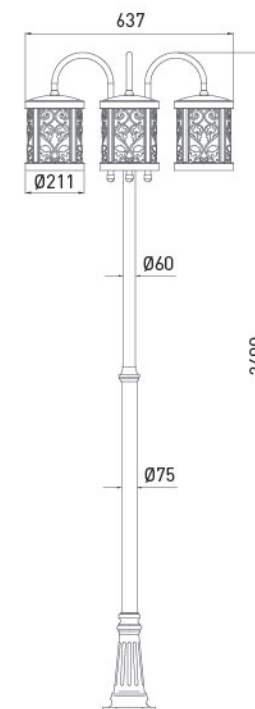

7111



7111

Serie Tim

Product feature:

- ※ Die Cast Aluminium Body
- ※ UV Resistant Powder Coating
- ※ PC diffuser
- ※ Brass or Stainless Steel Fasten Patrs

110V~240V / AC 50~60Hz
Max 100W E26 E27

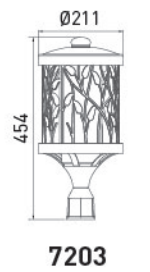
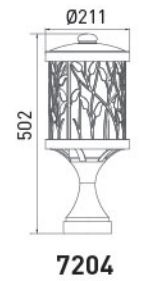
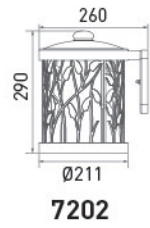

7202

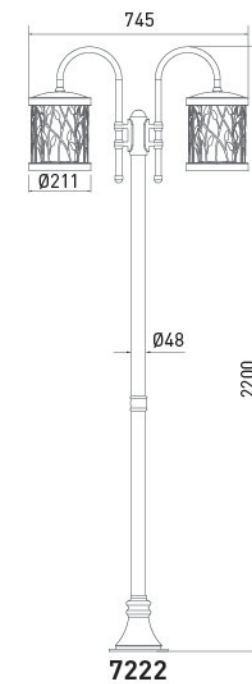
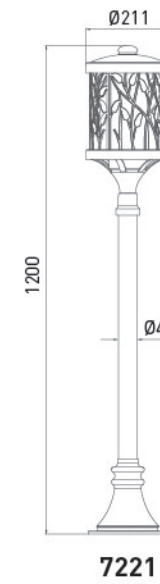
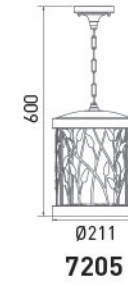

Serie Tim



7231

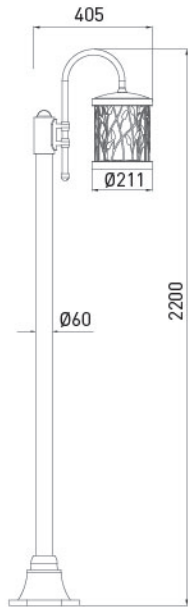

7231

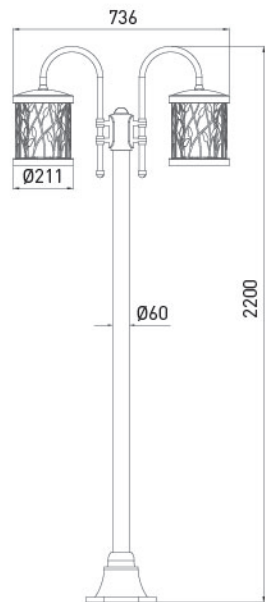

7232



7232

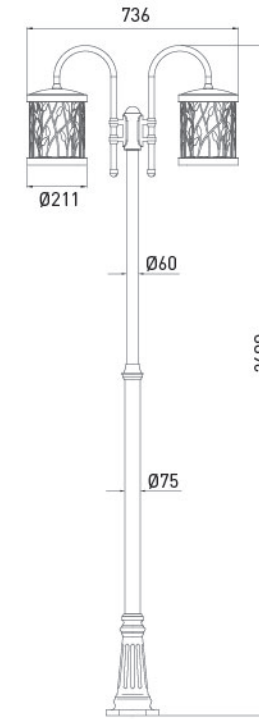

7210

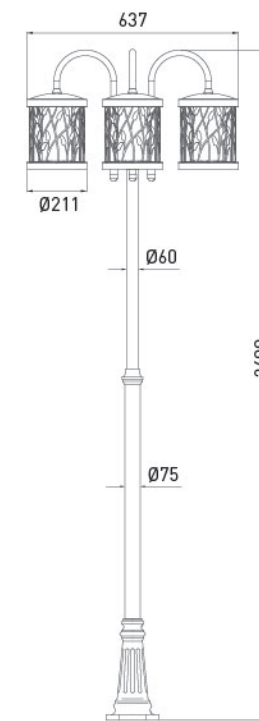

7211



7210



7211

Serie Rolling

Product feature:

- ✘ Die Cast Aluminium Body
- ✘ UV Resistant Powder Coating
- ✘ PC diffuser
- ✘ Brass or Stainless Steel Fasten Patrs

110V~240V / AC 50~60Hz
 Max 100W E26 E27

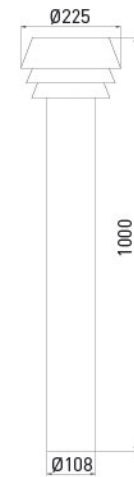

7310

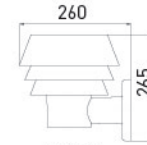

7301



7304

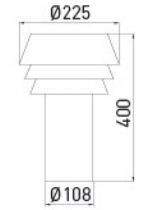

7301

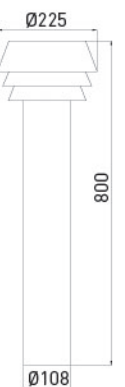
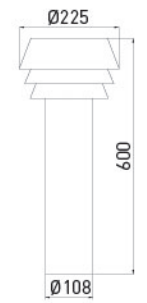

7310



7301



7304



7310

Serie Dalin

Product feature:

- × Die Cast Aluminium Body
- × UV Resistant Powder Coating
- × PC diffuser
- × Brass or Stainless Steel Fasten Patrs

110V~240V / AC 50~60Hz
 Max 100W E26 E27

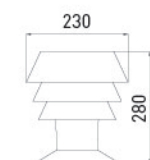

4904

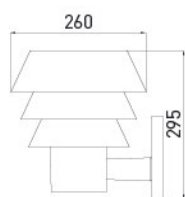

4901

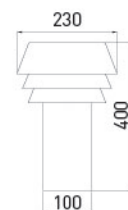

4910



4901



4904



4910

Serie Pie

Product feature:

- × Die Cast Aluminium Body
- × UV Resistant Powder Coating
- × Glass diffuser
- × Brass or Stainless Steel Fasten Patrs

220V~240V / AC 50Hz
 Max 13W E27

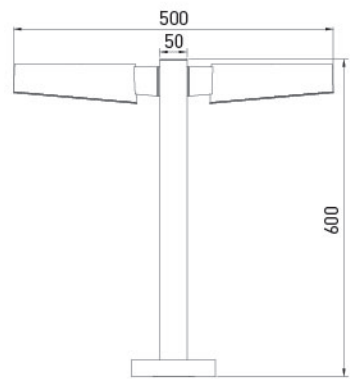

3405

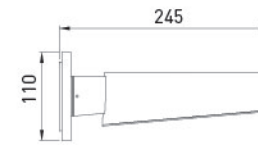

3401



3401

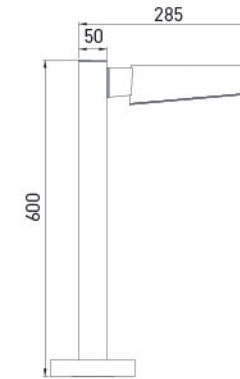

3404



3404

Moisture

Product feature:

- × Die Cast Aluminium Body
- × UV Resistant Powder Coating
- × Glass diffuser
- × Brass or Stainless Steel Fasten Patrs

220V~240V / AC 50Hz
E27

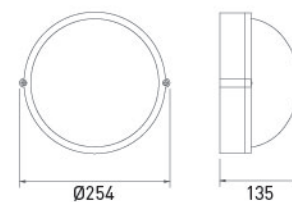

Max 100W

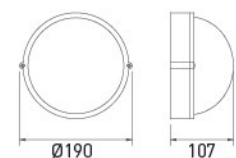

Max 60W



0103



0101 / 0301

0102 / 0302

0103 / 0303

0104 / 0304

0105 / 0305

0106 / 0306

0107 / 0307

0108 / 0308

Moisture

Product feature:

- × Die Cast Aluminium Body
- × UV Resistant Powder Coating
- × Glass diffuser
- × Brass or Stainless Steel Fasten Patrs

220V~240V / AC 50Hz
E27

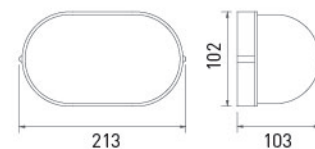

Max 60W

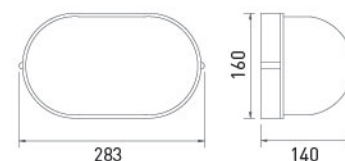

Max 100W



0201 / 0401

0202 / 0402

0203 / 0403

0204 / 0404

0205 / 0405

0206 / 0406

0207 / 0407

0208 / 0408



0201

Spotlight

Product feature:

- × Die Cast Aluminium Body
- × UV Resistant Powder Coating
- × Temper Glass
- × Brass or Stainless Steel Fasten Patrs

220V~240V / AC 50Hz

GU10



1001

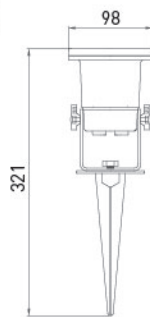

1004

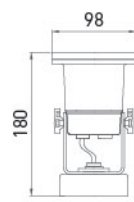

1002

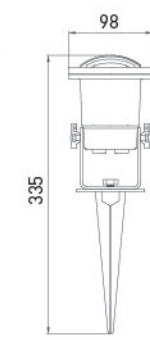

1005

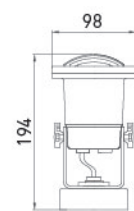

1003

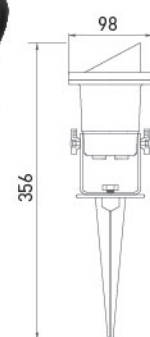

1006

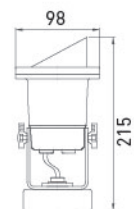

Moisture

Product feature:

- × Die Cast Aluminium Body
- × UV Resistant Powder Coating
- × Glass diffuser
- × Brass or Stainless Steel Fasten Patrs

220V~240V / AC 50Hz

Max 60W E27



0412

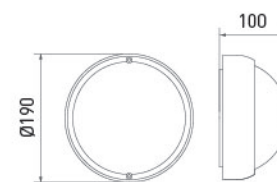

0311

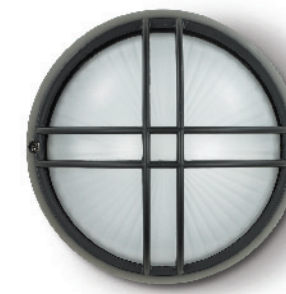

0312



0315

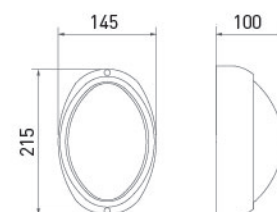

0411



0412



0415



Moisture

Product feature:

- × Die Cast Aluminium Body
- × UV Resistant Powder Coating
- × Glass diffuser
- × Brass or Stainless Steel Fasten Patrs

220V~240V / AC 50Hz
Max 60W E27



0812



0811



0812



0813

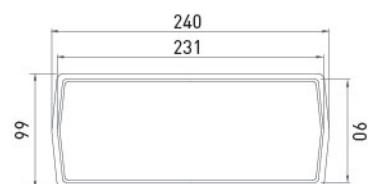
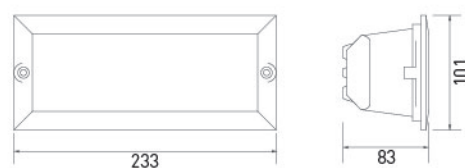

Landscape

Product feature:

- × Die Cast Aluminium Body
- × UV Resistant Powder Coating
- × Glass diffuser
- × Brass or Stainless Steel Fasten Patrs

220V~240V / AC 50Hz
E27



4101



Max 60W

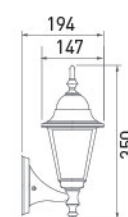

4101

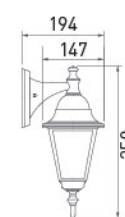

4102



4103

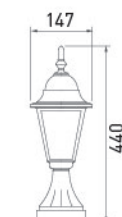

4104

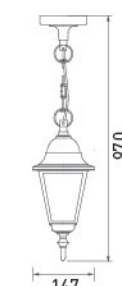

4105

Max 100W

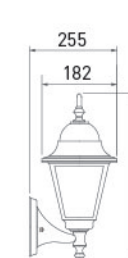

4201



4202



4203

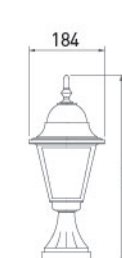

4204



4205

Landscape

Product feature:

- × Die Cast Aluminium Body
- × UV Resistant Powder Coating
- × Glass diffuser
- × Brass or Stainless Steel Fasten Patrs

220V~240V / AC 50Hz
 Max 100W E27

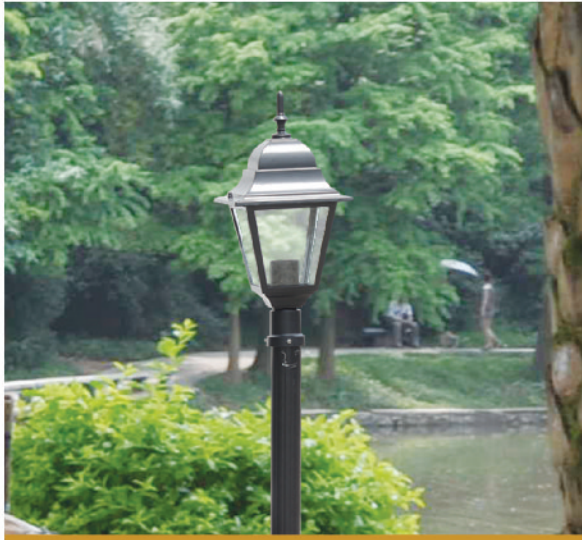

H4221

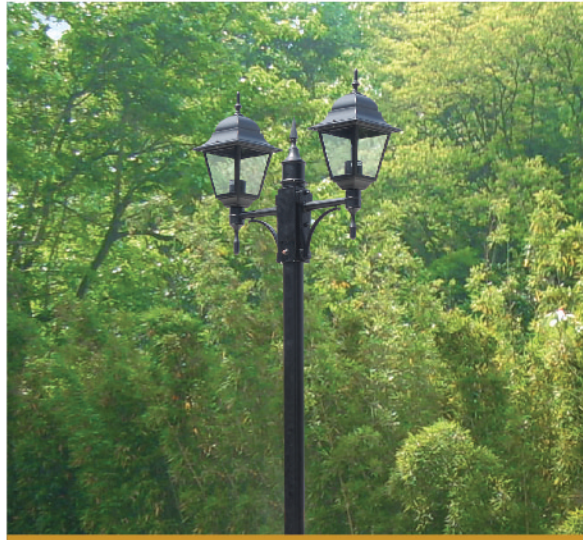

H4208

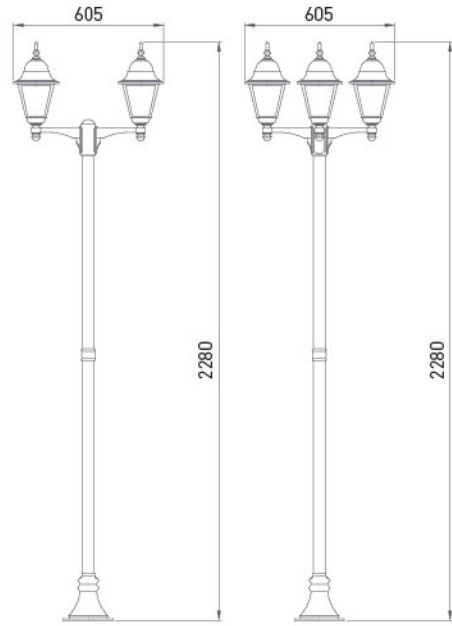

H4221

H4231

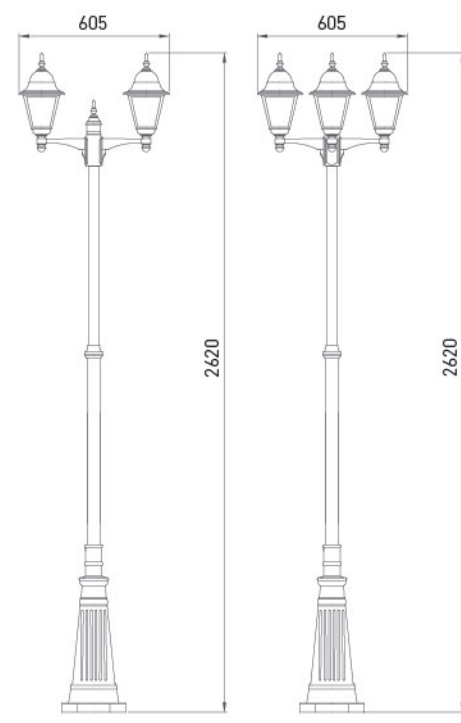
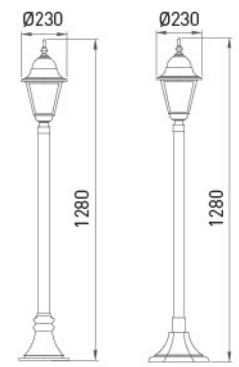

H4222

H4223

H4208

H4209

Product feature:

- ※ Die Cast Aluminium Body
- ※ UV Resistant Powder Coating
- ※ Glass diffuser
- ※ Brass or Stainless Steel Fasten Patrs

110V~240V / AC 50-60Hz
 Max 60W E26 E27

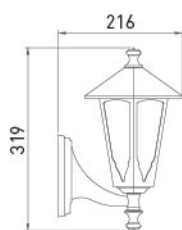

1601

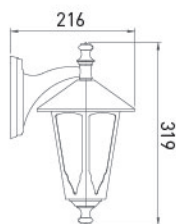

1602



1601

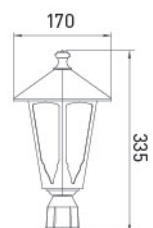

1603

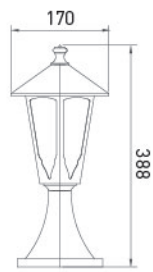

1604

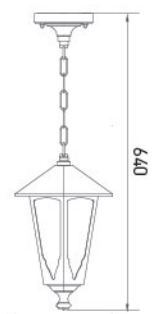

1605

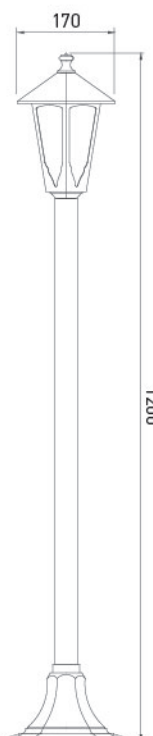

1606



1604



1602



1605

Landscape

Product feature:

- × Die Cast Aluminium Body
- × UV Resistant Powder Coating
- × Glass diffuser
- × Brass or Stainless Steel Fasten Patrs

220V~240V / AC E50Hz
E27



6108



Max 60W

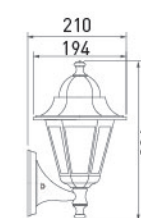

6101

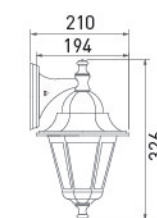

6102



6103



6104



6105

Max 100W



6201



6202



6203



6204



6205



Mounting can be changeable up and down, detail see A and B



6204

Landscape

Product feature:

- ✘ Die Cast Aluminium Body
- ✘ UV Resistant Powder Coating
- ✘ Glass diffuser
- ✘ Brass or Stainless Steel Fasten Patrs

220V~240V / AC 50Hz
 Max 100W E27



H6208

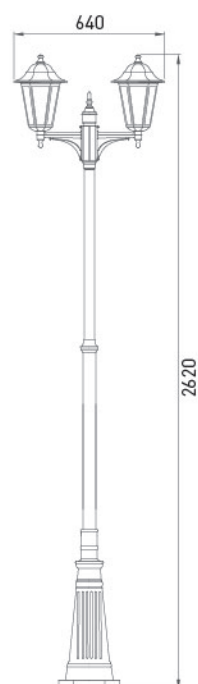

H6222

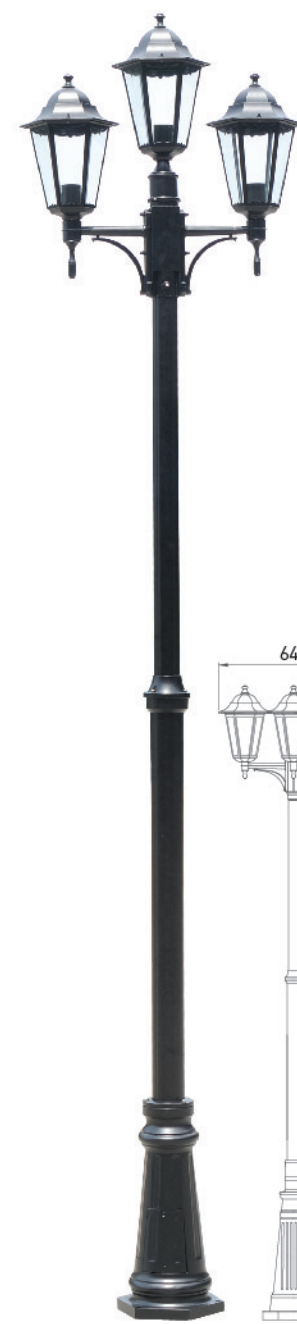

H6209

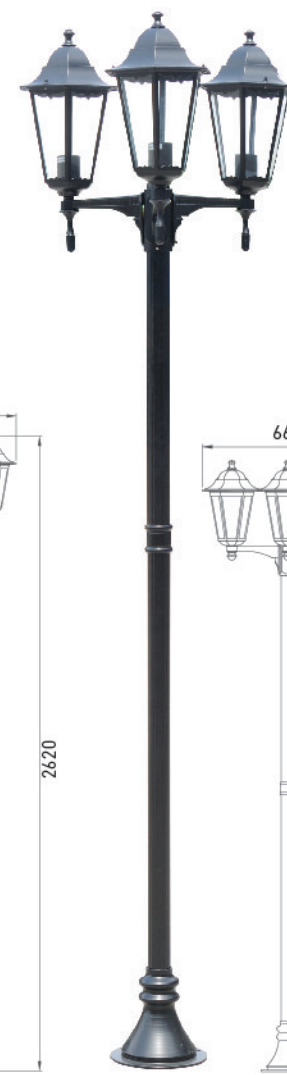

H6222



H6223



H6221

Serie-Rolling

Product feature:

- × Die Cast Aluminium Body
- × UV Resistant Powder Coating
- × PC diffuser
- × Brass or Stainless Steel Fasten Patrs

220V~240V / AC 50Hz
 Max 100W E27



3102



H3122

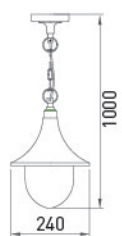

3105

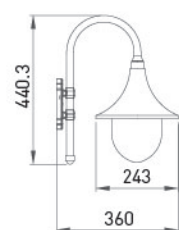

3102A

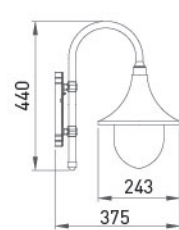

3102B

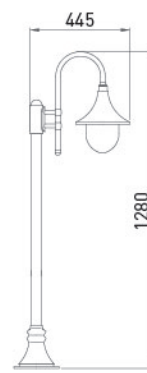

H3121

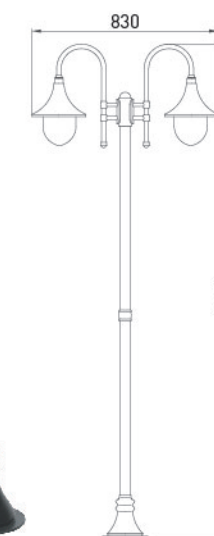

H3122

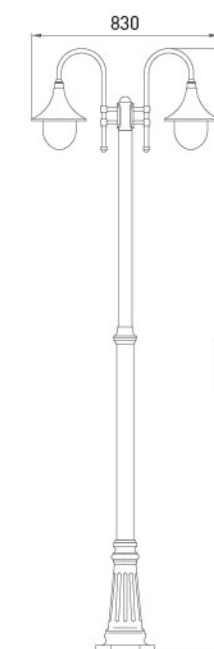

H3110

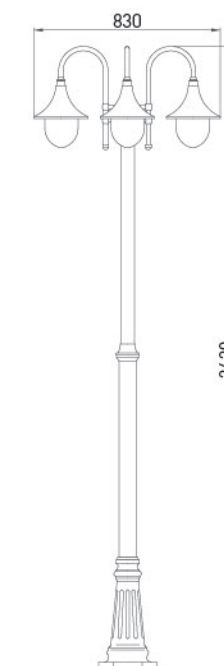

H3111

Landscape

Product feature:

- × Die Cast Aluminium Body
- × UV Resistant Powder Coating
- × PC diffuser
- × Brass or Stainless Steel Fasten Patrs

220V~240V / AC 50Hz
 Max 100W E27



5004

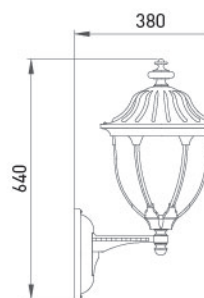
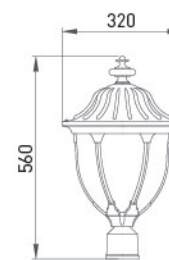
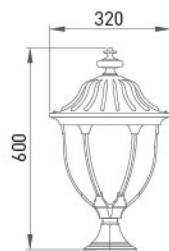

5003



5001



H5008

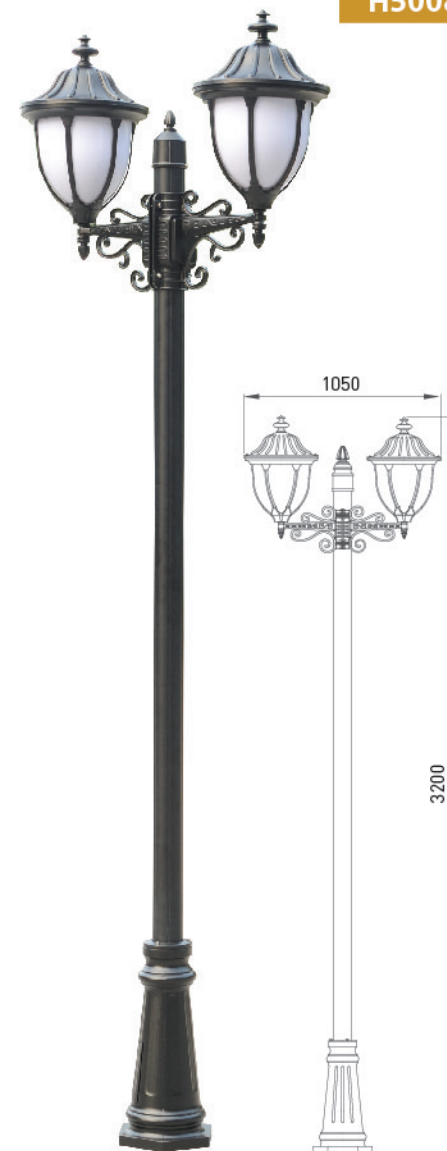

H5008



H5006



H5005

Landscape

Product feature:

- × Die Cast Aluminium Body
- × UV Resistant Powder Coating
- × PC diffuser
- × Brass or Stainless Steel Fasten Patrs

220V~240V / AC 50Hz
 Max 100W E27



6901

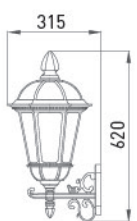

6901

MAX 60W



6900



259.8



6903



6904



H6908



H6912

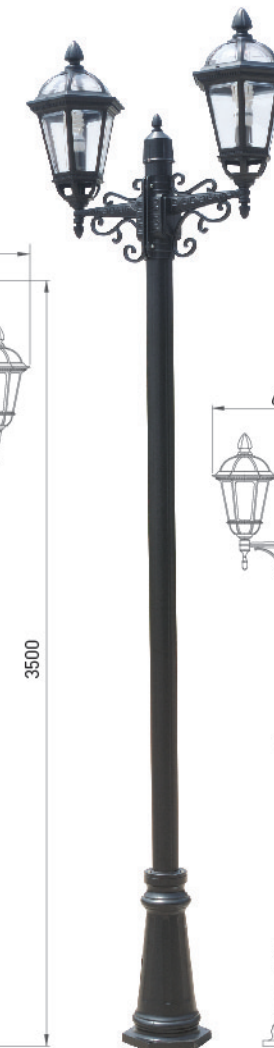

H6908

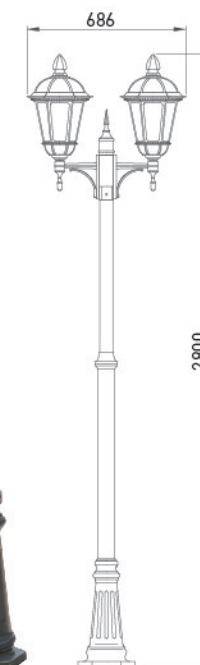

H6918

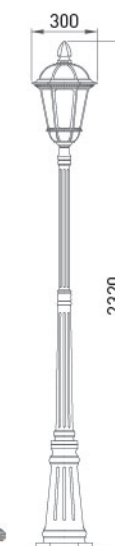

H6916



Landscape

Product feature:

- × Die Cast Aluminium Body
- × UV Resistant Powder Coating
- × Glass diffuser
- × Brass or Stainless Steel Fasten Patrs

220V~240V / AC 50Hz
Max 100W E27



8208



8204

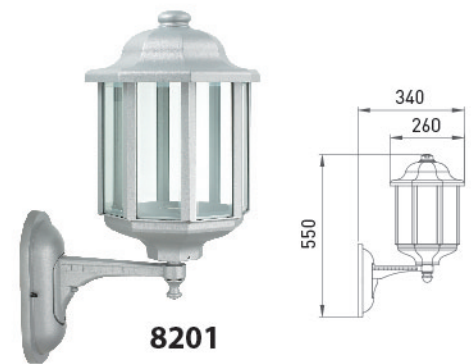

8201



8203



1035

Product feature:

- × Die Cast Aluminium Body
- × UV Resistant Powder Coating
- × Glass
- × Brass or Stainless Steel Fasten Patrs



Photometric with Lamp Supplied				
Model	Socket	Excl. Lamp	A	B
1031	E26 E27	Max 11w	Φ157	262
1032	E26 E27	Max 11w	Φ157	500
1033	E26 E27	Max 11w	Φ157	800
1034	E26 E27	Max 11w	Φ157	1000
1035	E26 E27	Max 11w	Φ157	1200

AC110~240V 50~ 60Hz

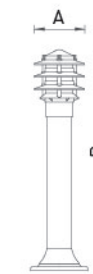

1044

Product feature:

- × Die Cast Aluminium Body
- × UV Resistant Powder Coating
- × Glass
- × Brass or Stainless Steel Fasten Patrs



Photometric with Lamp Supplied				
Model	Socket	Excl. Lamp	A	B
1041	E26 E27	Max 11w	Φ160	255
1042	E26 E27	Max 11w	Φ160	500
1043	E26 E27	Max 11w	Φ160	800
1044	E26 E27	Max 11w	Φ160	1000
1045	E26 E27	Max 11w	Φ160	1200

AC110~240V 50~ 60Hz

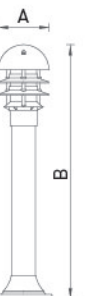

Product feature:

- × Die Cast Aluminium Body
- × UV Resistant Powder Coating
- × Glass diffuser
- × Brass or Stainless Steel Fasten Patrs

110V~240V / AC 50-60Hz
 Max 60W E26 E27

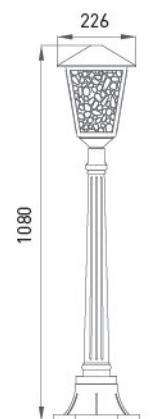

1478/1478A



1478 / 1478A

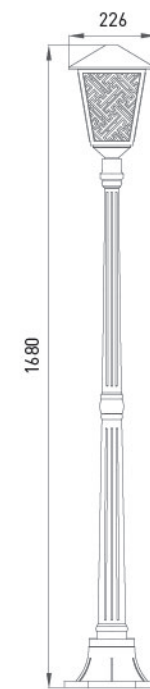

1489/1489A



1489 / 1489A



1459 / 1459A

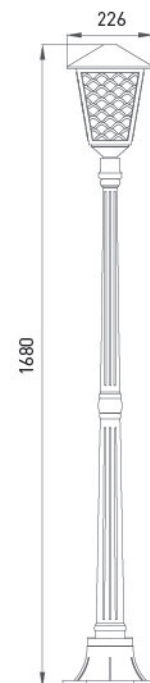

1680

226



1469 / 1469A

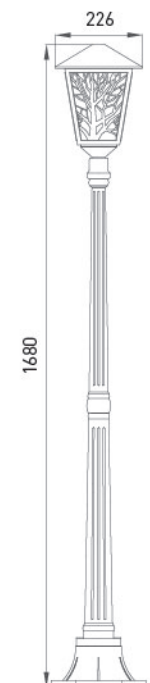

1680

226



1479 / 1479A

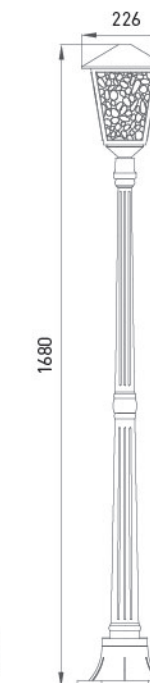

1680

226



1458 / 1458A

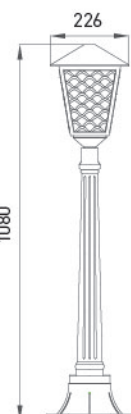

1080

226



1468 / 1468A

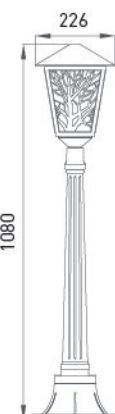

1080

226



1488 / 1488A

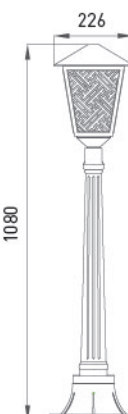

1080

226